

DETAIL C
SCALE 5 : 2

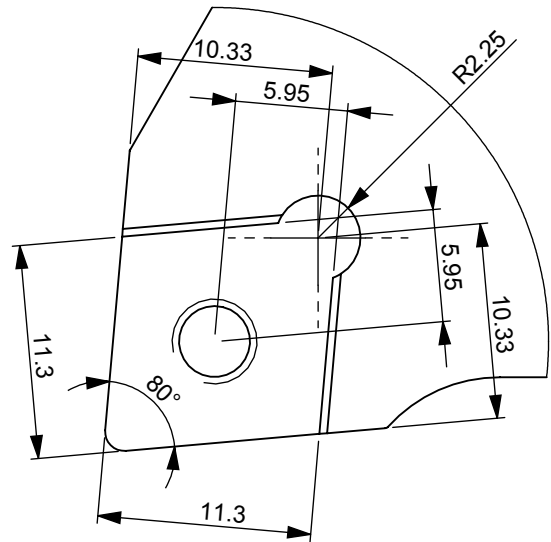

DETAIL D
SCALE 5 : 2

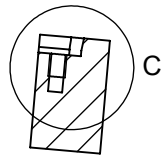

SECTION B-B

